



Energy-Saving Refrigeration Dryers

SECOTEC® TD, TE, TF and TG Series

Efficient, compact and maintenance-friendly
Flow rate 5.1 to 98 m³/min, Pressure 3 to 16 bar

www.kaeser.com

SECOTEC® TD, TE, TF and TG series

Compact, energy-saving refrigeration dryers with impressive latent heat storage

KAESER's renowned, industrial-quality **SECOTEC** series refrigeration dryers have long been valued for their stable pressure dew point performance, exceptional reliability and low life-cycle costs. Now, the enhanced second generation offers even greater efficiency with a more compact design and further-optimised user-friendliness, thanks to such features as: the compact SECOPACK LS heat exchanger system with its high-efficiency latent heat storage, the network-capable SIGMA CONTROL SMART controller, and the innovative exhaust air control fitted to air-cooled refrigeration dryers from 45 m³/min. Furthermore, with climate-friendly R-513A refrigerant, KAESER assures security of supply for the future.

Energy cost savings

SECOTEC refrigeration dryers impress with their exceptional energy efficiency. Thanks to their energy-saving control, surplus cooling performance can be stored temporarily in the thermal mass during partial load operation and subsequently used for drying, without the need for additional energy consumption. The rapid-reaction SECOPACK LS heat exchanger system ensures stable pressure dew points at all times.

Optimised and compact

The thermal mass storage in the highly efficient SECOPACK LS heat exchanger system is filled with a phase change material which, thanks to its significantly higher thermal storage density, requires 98% less storage material to achieve the same capacity as conventional storage media. This not only ensures excellent pressure dew point stability, but also allows the footprint of the unit to be significantly reduced. Optimised flow paths minimise pressure losses, thereby helping to enhance the efficiency of **SECOTEC** dryers.

Intuitive operation

The electronic SIGMA CONTROL SMART controller with colour display and language-neutral menu navigation is simple and intuitive to operate. Message memory, component-specific operating hour counters and maintenance timers enable efficient monitoring and analysis of operating data. Floating contacts and a Modbus TCP communications module (optional with TD series) provide easy networking with master controllers such as the SIGMA AIR MANAGER 4.0.

Long-term reliability

The high-performance refrigerant circuit in **SECOTEC** refrigeration dryers delivers reliable performance in ambient temperatures up to 50 °C. The large condensate separator and electronic ECO-DRAIN condensate drain provide reliable condensate removal during all load phases. Long service life is assured through the use of aluminium for the condenser and SECOPACK LS, whilst the corrosion-resistant compressed air piping further enhances durability. The innovative exhaust air control fitted to the **SECOTEC** TG reliably conveys away the exhaust heat, ensuring efficient and long-lasting operation.

Reduce life-cycle costs!

Three factors are responsible for achieving the exceptionally low life-cycle costs associated with **SECOTEC** refrigeration dryers, namely: low-maintenance system design, energy-efficient components and, above all, the demand-dependent **SECOTEC** energy-saving control.

This triple combination enables a **SECOTEC** TF 340, for example, to achieve life-cycle cost savings of up to 50% when compared to other typically available refrigeration dryers.

SECOTEC TF 340 example:

Flow rate 34 m³/min, 40% load, 6.55 kW/(m³/min), extra energy demand 6% per bar, 0.20 €/kWh, 6,000 operating hours per year, annual debt service over 10 years

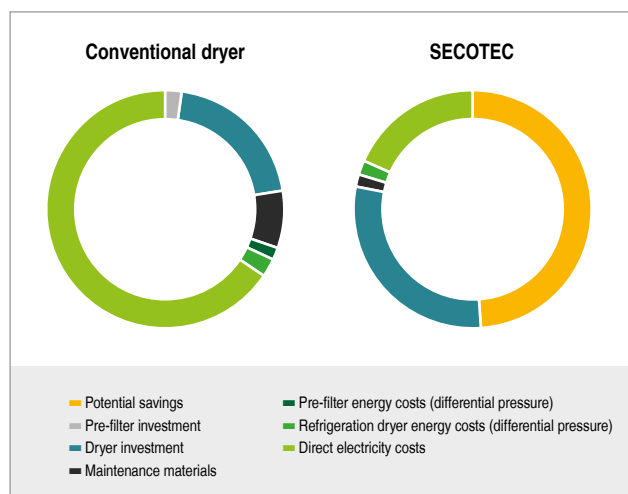

Efficient, compact, maintenance-friendly



Image: SECOTEC TF 340



SECOTEC® TD, TE, TF and TG series

Energy-efficient powerhouses

Consistent use of high-quality components and our decades of experience in system design enable **SECOTEC** refrigeration dryers to achieve world-class energy efficiency – across the entire load range.



Efficient refrigerant compressors

All **SECOTEC** dryers are equipped with energy-saving refrigerant compressors. Their exceptional performance helps keep electrical power consumption in **SECOTEC** dryers to an absolute minimum, thereby ensuring outstanding overall efficiency.

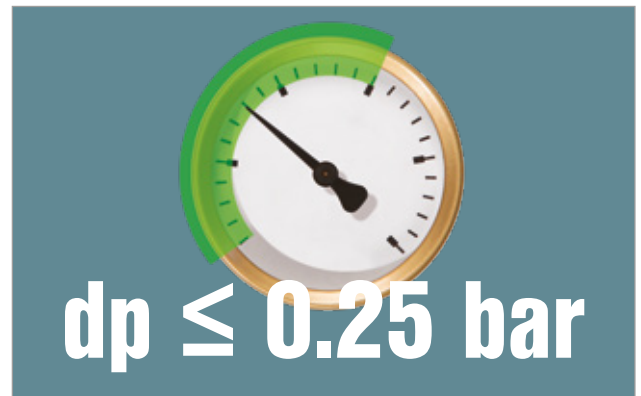

Minimal differential pressure

Second-generation **SECOTEC** refrigeration dryers stand out for their remarkably low differential pressure. This is a result of the generously dimensioned flow cross-sections within the heat exchanger and compressed air connection lines.



Efficient thermal mass

The efficient phase change material gives the compact SECOPACK LS heat exchanger system its impressive thermal mass storage capacity. Special heat transfer elements ensure rapid charge and discharge, whilst premium-grade heat insulation boosts efficiency even further.



Significant energy savings

The SIGMA CONTROL SMART controller calculates the new **SECOTEC** dryer's load hours and current actual power consumption. This advanced system also displays the savings achieved compared with conventional hot gas bypass refrigeration dryers.

SECOTEC® TD, TE, TF and TG series

Reliable drying

We do more than talk about challenging operating conditions – we actually create them using our advanced climate testing facilities. This allows us to fine-tune the design of **SECOTEC** refrigeration dryers to ensure maximum reliability at all times.



Controlled availability

The innovative SIGMA CONTROL SMART controller regulates operation of the thermal mass whilst constantly monitoring system temperature and pressure values. Automatic wire break and short circuit monitoring add even greater operational security.



Compact condenser

Aluminium microchannel condensers with large surfaces ensure effective contamination reserve, whilst their compact design saves both space and refrigerant quantities. This enables **SECOTEC** refrigeration dryers to deliver reliable drying performance even at high ambient temperatures.



Reliable separation

The SECOPACK LS heat exchanger system is made of corrosion-resistant aluminium and includes an integrated, large-diameter condensate separator for reliable separation of condensate during all load phases.



Future-proof refrigerant

The refrigerant circuit in SECOTEC refrigeration dryers is specifically designed for the use of R-513A refrigerant. This ensures maximum efficiency and reliability, even at higher temperatures, whilst providing the best solution available for the security of your future supplies.

Dependable
performance
up to

50 °C

ambient temperature



SECOTEC® TD, TE, TF and TG series

Easy installation and excellent accessibility

KAESER understands customers' needs very well, as the company itself operates numerous compressed air stations. From first-hand experience, we are well versed in all aspects of compressed air station planning, commissioning, operation and maintenance. We draw on this expertise to create user-friendly products with minimal need for maintenance.



Left-hand side compressed air connections (optional)

If required, **SECOTEC** TF refrigeration dryers are available with compressed air connections located at the top of one side. This customised solution enables rapid installation at low cost.



Externally accessible: ECO-DRAIN

The standard-fit ECO-DRAIN electronic condensate drain is conveniently located on the exterior of the unit, where it is easily accessible for functional testing. The service unit can be replaced without depressurisation of the refrigeration dryer by simply closing the condensate inlet valve.

SECOTEC – Ultimate space-savers

TD, TE and TF series...



...with two wall sides

SECOTEC TD, TE and TF series units can be installed against walls on two sides, achieving even further space savings.

TD, TE and TF series...



...as a compact duo

Where multiple energy-saving refrigeration dryers are required, **SECOTEC** TD, TE and TF series units can easily be installed together as a compact duo.



Image: SECOTEC TD 73



Image: SECOTEC TG 780

Quick maintenance access

With **SECOTEC** TD, TE and TF series units, removable panels allow easy access to all maintenance-relevant components. On TG series units and upwards, maintenance access is provided via large doors. The microchannel condenser is also easily accessible for cleaning purposes.

TD, TE, TF and TG series...



...back to back

Two energy-saving refrigeration dryers and not much space? No problem! **SECOTEC** TD, TE, TF and TG series refrigeration dryers are equipped for back-to-back installation.

TG series...



...with one wall side

The **SECOTEC** TG series combines maximum performance with a minimal space requirement. Even installation on one wall side poses no problem.

Comprehensive information and intuitive operation

The new generation of **SECOTEC** refrigeration dryers is equipped with the SIGMA CONTROL SMART electronic controller. With its colour display and language-neutral menu navigation, this advanced controller is exceptionally user-friendly.

Operational status can be viewed at a glance via the dew point trend indicator, prominent display of active messages and current operating data, as well as a clear P&I diagram. Furthermore, a message memory and floating message contacts, together with the standard-equipped network interface (optional with TD series), provide highly effective analysis and monitoring capability. All information can be communicated to a master controller via the SIGMA NETWORK.



Main menu

- Pressure dew point trend indicator
- Eco-symbol displayed when thermal mass activated
- List of additional menus, symbols: Controller under voltage, fault, warning/maintenance, remote on/off, controller on
- Status indicators for component-specific messages
- Flagging of pending maintenance/warning and affected component
- Faults requiring action indicated in red

KAESER
SECOTEC TF 340

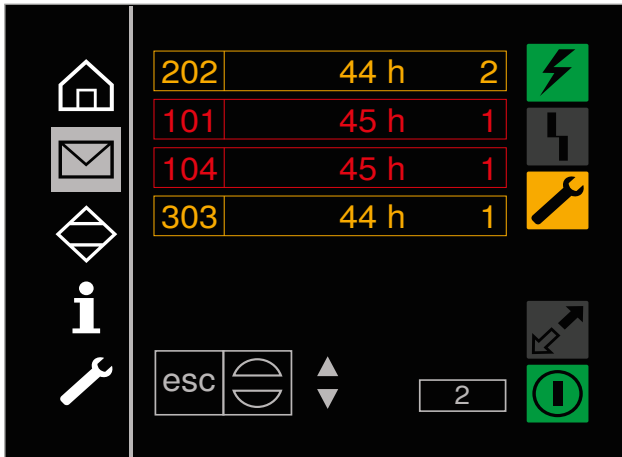

Messages

- Maintenance/warning: indicated in orange
- Faults: indicated in red
- Unacknowledged message: indicated by a border
- Messages identifiable by numerical codes
- Messages timestamped with operating hours
- Counter shows number of past messages

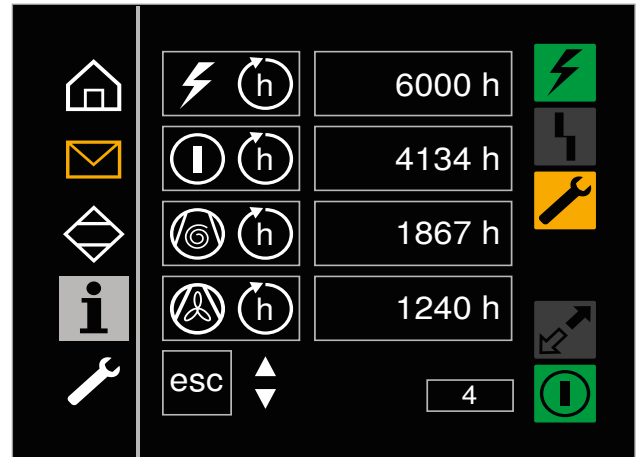

Information

- Multiple operating hour counters
- Temperature thresholds for messages
- Activation of remote on/off
- Display of actual electrical power consumption
- Estimated energy savings compared to dryers with hot gas bypass control
- Change measurement units

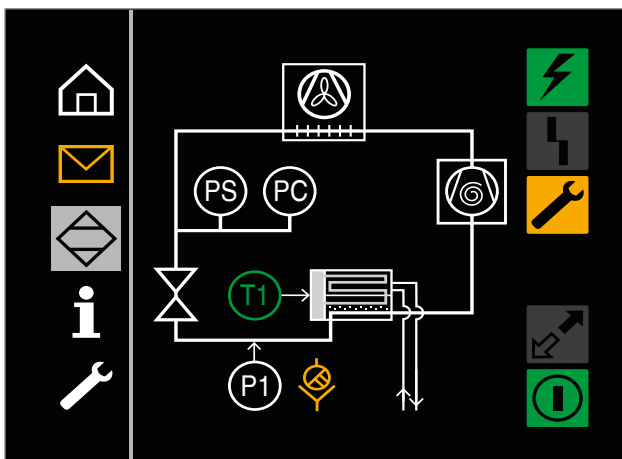

P&I diagram

- Displays functional principle
- Messages displayed with coloured switch symbols (e.g. condensate drain maintenance)

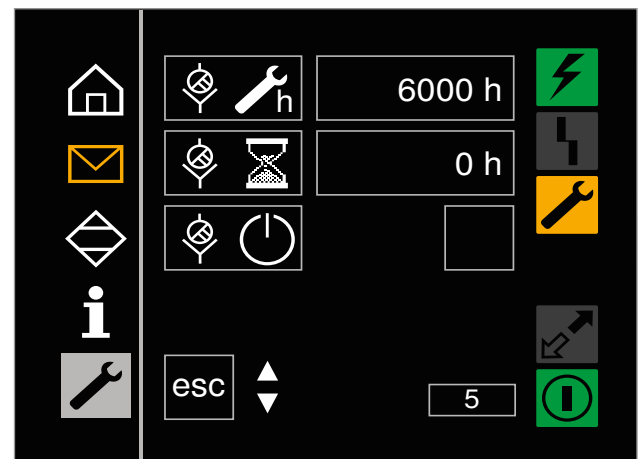

Service

- List of individual maintenance intervals for condensate drain and condenser cleaning
- Current interval status
- Reset maintenance timer

Innovative energy-saving control with Storage Plus

For its Storage Plus energy-saving control, KAESER uses a special phase change material (PCM) that can extract latent heat. In contrast to other available thermal mass storage systems, the heat energy does not go through a temperature change; rather, it goes through a phase change. Only when the entire medium has undergone this

phase change – meaning that the storage is now full – does the temperature begin to rise. When the latent heat is discharged, the phase change reoccurs in the opposite direction, with the temperature remaining constant until all the heat has been discharged.

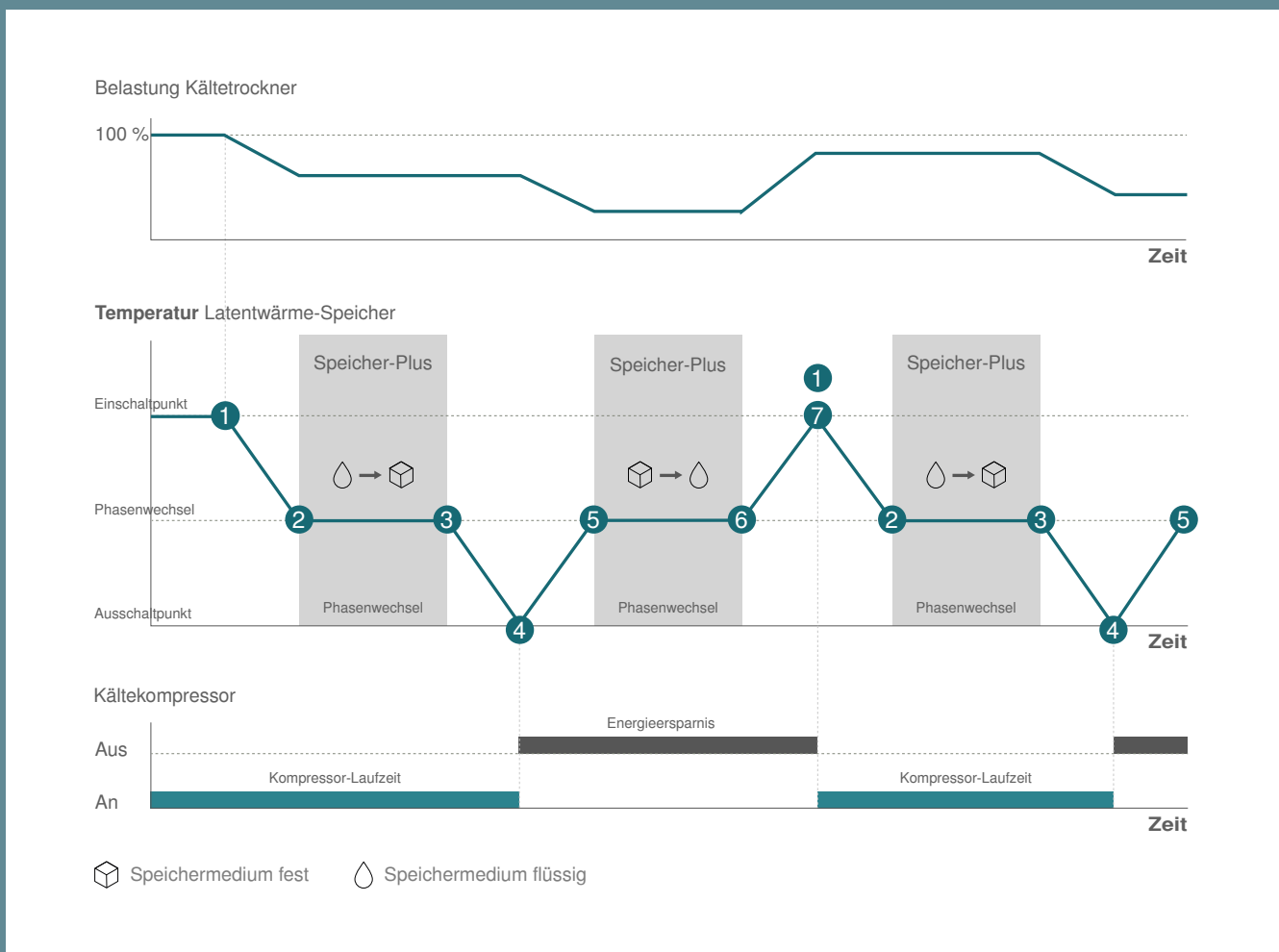

- (1) Refrigerant compressor runs: Cooling is supplied for drying the compressed air and cooling down the thermal mass.
- (2) Thermal mass solidifies at constant temperature and transfers a significant amount of heat to the refrigerant.
- (3) Refrigerant cools the thermal mass down further until the cut-out temperature is reached.
- (4) Refrigerant compressor switches off.

- (5) Thermal mass provides cooling for drying of the compressed air and, in doing so, warms up.
- (6) Thermal mass melts at constant temperature, taking on a significant amount of heat from the moist compressed air.
- (7) Thermal mass warms up to the cut-in temperature of the refrigerant compressor.

Modbus TCP communications module

SECOTEC – Industrie 4.0 ready

With their standard-fit Modbus TCP module, **SECOTEC** refrigeration dryers can be connected to the SIGMA AIR MANAGER 4.0 and the SIGMA NETWORK. All essential operating parameters and messages are available in real time, enabling comprehensive monitoring of the entire compressed air station and creating the basis for demand-oriented preventative maintenance.

The result: maximum availability at minimal cost. Furthermore, the SIGMA AIR MANAGER 4.0 provides a comprehensive overview of all of the refrigeration dryer's essential operating parameters. Colour-coded warnings and alarms are displayed in the compressed air station's flow diagram. By selecting the dryer icon, all key operating parameters and message texts are displayed in plain text.

SIGMA AIR MANAGER 4.0

Station: SAM 4.0 / 4, Automatikbetrieb, 6.62 bar, DE

Leistung: 128.50 kW, Volumenstrom: 24.55 m³/min

Station components: C1 - DSDX 245, C2 - DSDX 245, Trockner: D1 - TF 340, D1 - TF 340, Filter, Behälter, Kondensatufbereitung.

Flow diagram labels: C1, D1, F1, F1, R1, DHS1, C2, D2, F2, F2, CT1, CT2.

Right sidebar menu: Status, Meldungen, Monitoring, Energie & Kosten, Wartung, Regelung, Zeitsteuerung, Inbetriebnahme, Konfiguration, Kontakt.

D1 - TF 340

Typenbezeichnung: TF 340

Elektrische Leistungsaufnahme: 2.53 kW
Drucktaupunkt: **Normal**
Warngrenze gelber Bereich: 14.0 °C
Warngrenze roter Bereich: 20.0 °C

Automatischer Wiederanlauf: Ja
Fernsteuerung: Nein

Betriebsstunden: 10598 h
Restwartungsstunden Kondensatableiter: 1374 h
Restwartungsstunden Verflüssiger reinigen: -17 h
Sammelwarnung: Nein
Sammelstörung: Nein

Wartung „Verflüssiger reinigen“ fällig

Schließen

SIGMA CONTROL SMART

SIGMA AIR MANAGER 4.0

Networked compressed air station

SECOPACK LS heat exchanger system

The high-efficiency module for maximum energy savings

Second-generation **SECOTEC** refrigeration dryers are equipped with the innovative SECOPACK LS heat exchanger system. Its latent heat thermal mass is composed of a phase change material. Compressed air warms the material up to its melting point (thermal mass discharge), absorbing latent melt heat in the process. This is significantly more than the amount of heat that it can absorb based on its normal specific heat capacity (without the phase change properties), so the latent heat thermal mass in SECOTEC dryers has a significantly higher thermal density than equivalent conventional systems and is therefore capable of delivering the same performance using 98% less thermal mass material.

The result: High thermal mass storage capacity for stable pressure dew points and long-life operation, combined with a significantly reduced unit footprint.

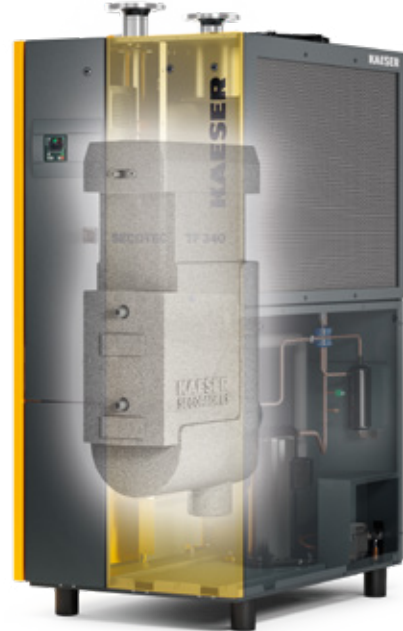
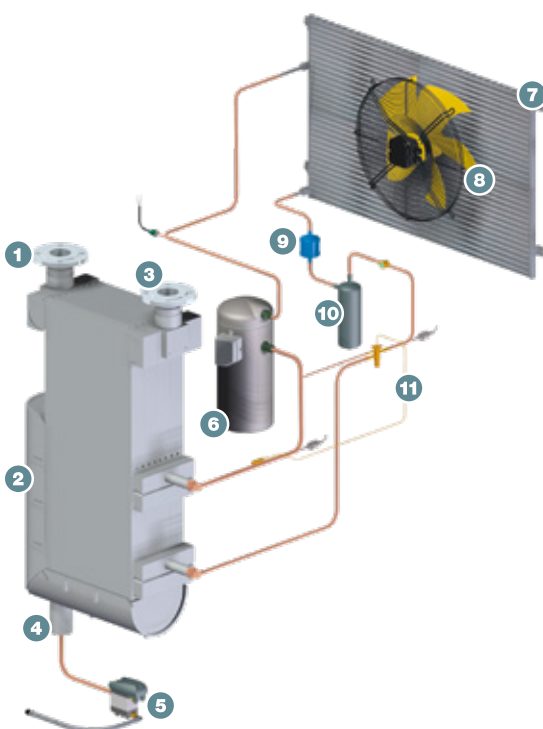
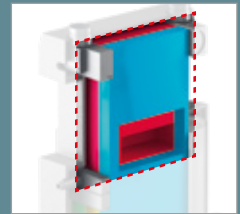
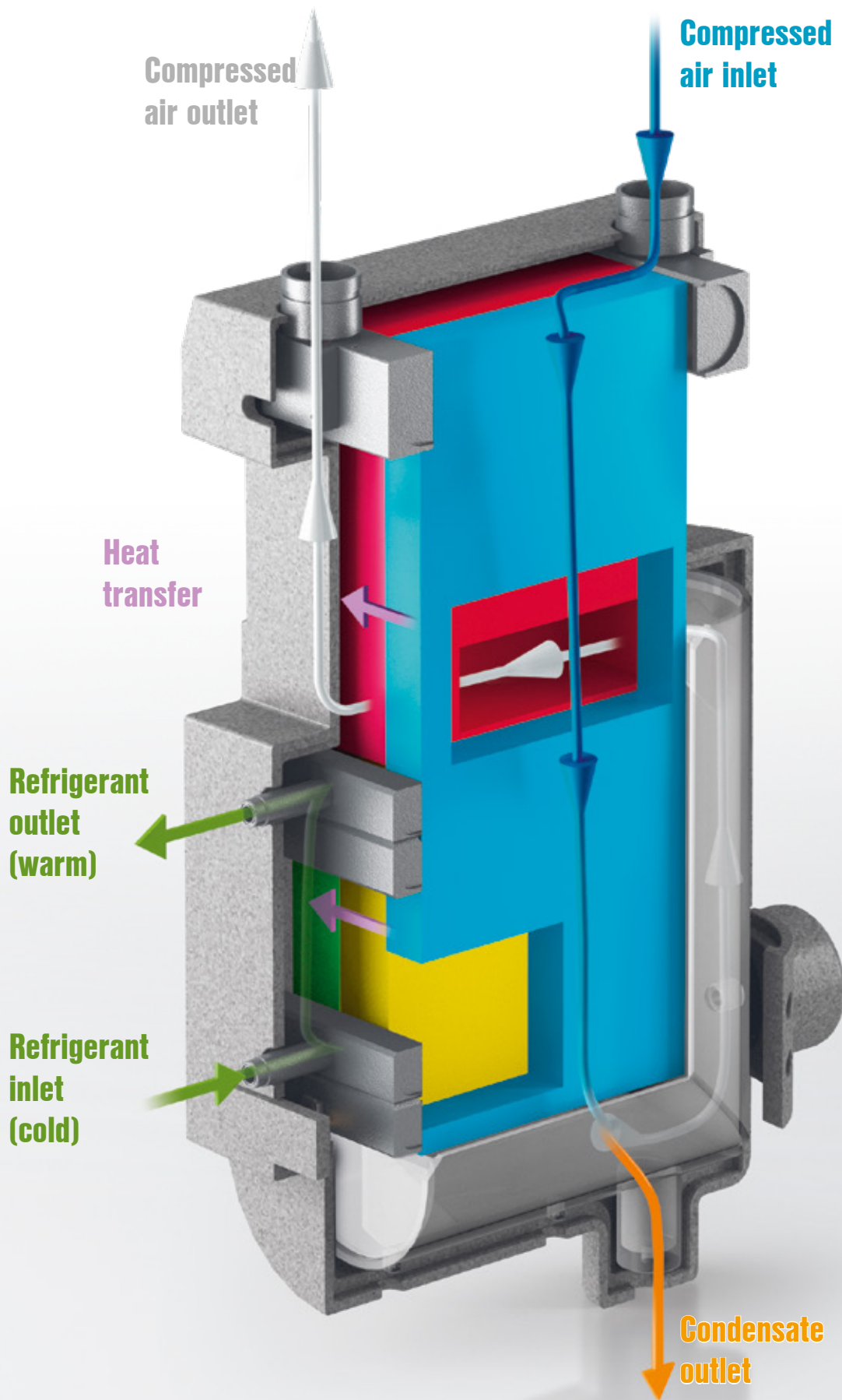

Image: SECOPACK LS in the SECOTEC TF



Design

- (1) Compressed air inlet
- (2) SECOPACK LS heat exchanger system
- (3) Compressed air outlet
- (4) Condensate outlet
- (5) ECO-DRAIN condensate drain
- (6) Refrigerant compressor
- (7) Microchannel condenser
- (8) Fan
- (9) Filter dryer
- (10) Refrigerant collector
- (11) Expansion valve



Air/air heat exchanger

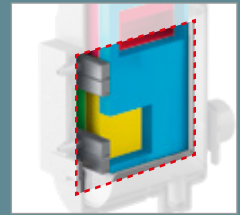

Air/refrigerant heat exchanger

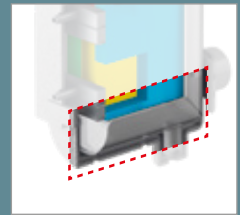

Condensate separator

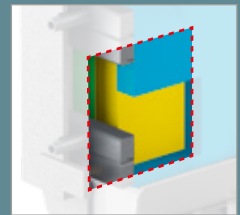

Thermal mass (yellow section)

Image: SECOPACK LS

SECOTEC TG series

SECOTEC TG – The compact powerhouse

SECOTEC TG series energy-saving refrigeration dryers can accommodate flow rates up to 98 m³/min and are available with a choice of air- or water-cooling. Designed for large-scale industry, these compact powerhouses ensure stable pressure dew point performance even under the toughest of operating conditions – with maximum reliability and minimal life-cycle costs.

The high-performance thermal mass concept and standard, network-capable SIGMA CONTROL SMART controller guarantee long-lasting, energy-saving operation in all load phases. The innovative exhaust air control, fitted on air-cooled variants, sets new standards for operational reliability and cost efficiency.



Innovative exhaust air control

Dependent on load, the frequency-controlled radial fan draws off the accumulating exhaust heat from the refrigeration dryer via the cooling air flow. Thanks to a high residual thrust of 150 Pa and autonomous control, direct connection to standard exhaust and collector ducting is possible.

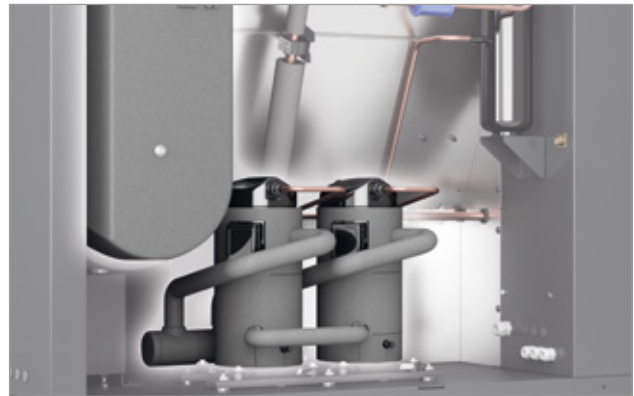

Thermal mass concept with multiple compressors

The SECOPACK LS heat exchanger system with latent heat thermal mass operates in combination with up to three refrigerant compressors arranged in parallel. These are switched continuously according to the load level, thereby relieving the load on the thermal mass, allowing it to be made even more compact.



Reduced operator obligations

Thanks to its compact components, the **SECOTEC TG** operates using particularly low levels of refrigerant charge. Low greenhouse gas potential also ensures cost-effective compliance with national operator obligations. Furthermore, there is no need to perform the leak tests required under the European F-gas regulations (EU 517/2014). However, it is still recommended to have the unit inspected once per year by a certified expert.



Minimal service costs

The condensate separator in the SECOPACK LS does not require servicing. It is just a matter of replacing the service unit in the standard ECO-DRAIN condensate drain – no further maintenance work is required. Unlike typical axial fans, the radial fans in the **SECOTEC TG** are designed to last for the unit's entire service life.



**MADE IN
GERMANY**



Image: Cooling air flow (red) with SECOTEC TG units

SECOTEC TG series

Advantages of the innovative exhaust air control compared to previous models

No risk of thermal overload

Refrigeration dryers are usually supplied without a dedicated exhaust air duct. This can result in thermal overload caused by hot exhaust air being drawn back in as cooling air. However, the innovative exhaust air control on the **SECOTEC TG**, coupled with its direct connection to the exhaust air duct, reliably prevents this issue from occurring.

No intake of room air, no auxiliary fan

In the case of conventional ventilation systems, which use air hoods and auxiliary fans, air from the room is invariably drawn in. Not so with the **SECOTEC TG**: the exhaust air flow is minimised, which means smaller ducting can be used and the auxiliary fan becomes redundant.

Innovative exhaust air control

Its innovative exhaust air control allows the exhaust air ducting to be connected directly to the compressor station; the resulting significant space-savings reduce planning and installation costs. Optimal cooling also ensures stable pressure dew points and long-lasting, energy-saving operation.

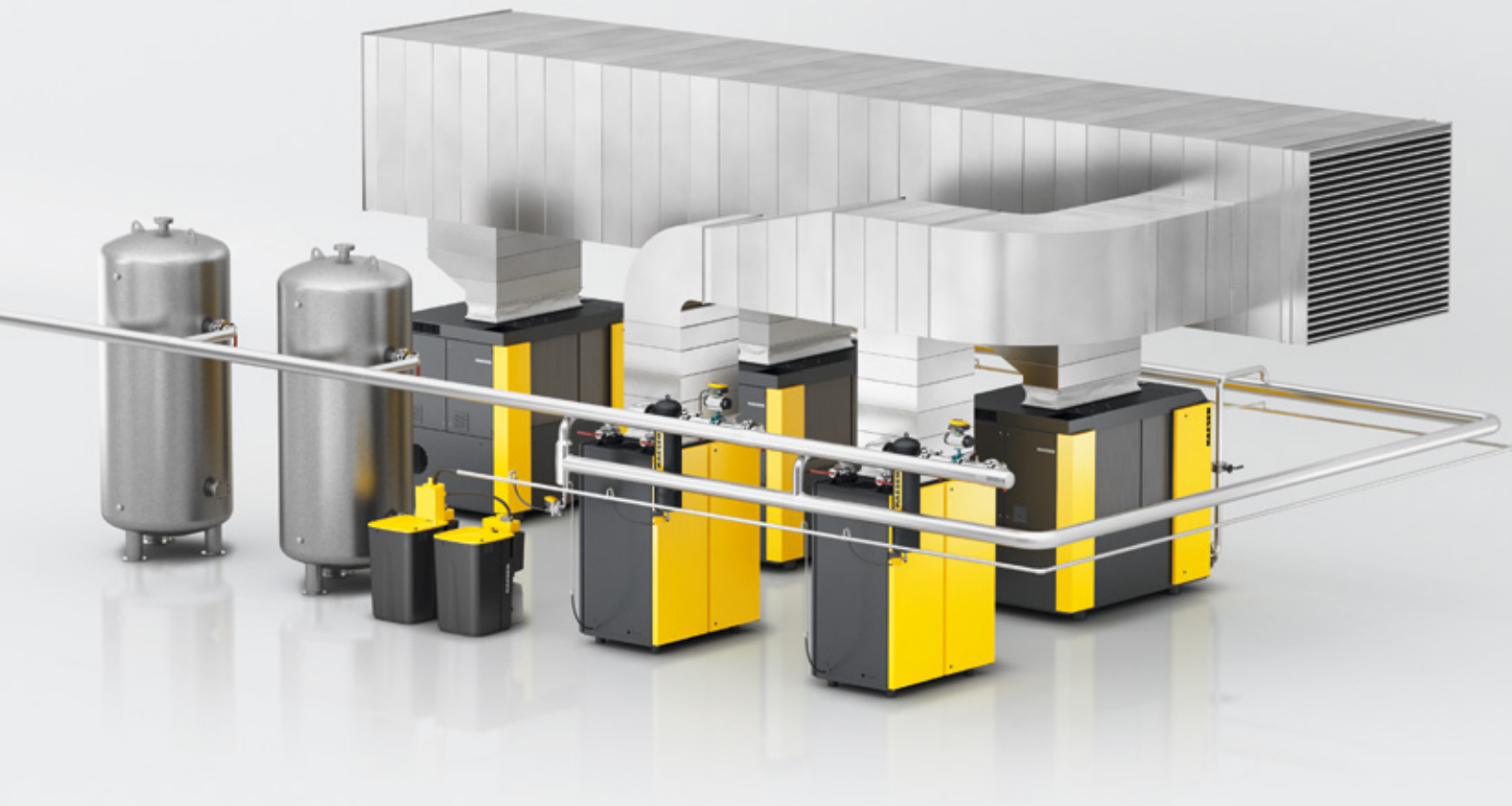
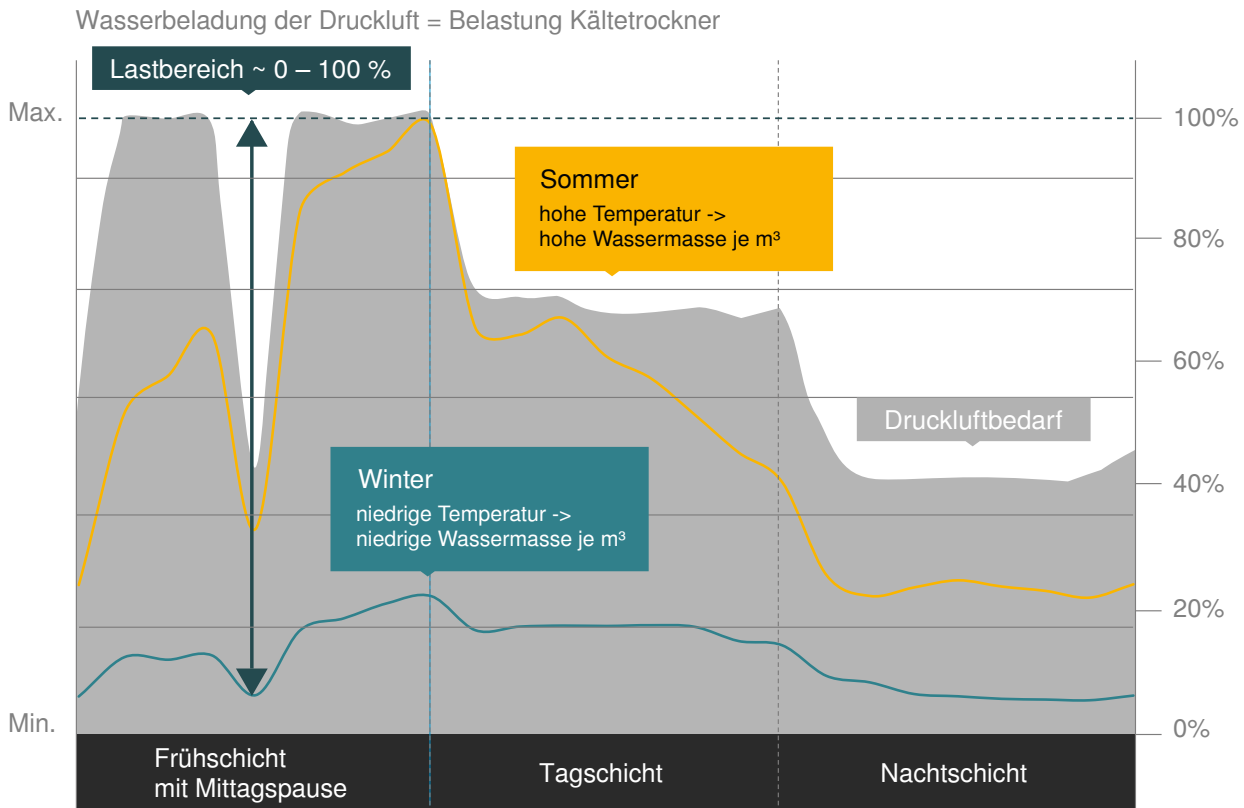

Image: Example air station with collector duct for compressors and refrigeration dryer

The key to perfect refrigeration drying



SECOTEC - Savings for all seasons

The load on a refrigeration dryer depends not only on the volume of compressed air to be dried (grey area), but more importantly, on how much water the incoming compressed air contains. This volume of water (moisture) increases as the temperature rises, so the load on refrigeration dryers increases dramatically when ambient temperatures are high, such as during the summer (yellow curve) months.

Lower temperatures during the winter (teal blue curve) therefore reduce the load on refrigeration dryers accordingly. To maintain a stable pressure dew point despite these fluctuating conditions, refrigeration dryers should always be designed to provide sufficient performance during peak load times, and should also have additional

reserve capacity.

To accommodate these fluctuations in flow rate and temperature range, refrigeration dryers constantly operate in the load range between 0 and 100%. Because the **SECOTEC** thermal mass control ensures energy is only used as and when needed across the entire load range, users benefit from exceptional savings.

Maximum energy savings thanks to thermal mass control

Refrigeration dryer load constantly fluctuates between 0 and 100%. Unlike conventional partial load control systems, **SECOTEC** thermal mass control precisely adjusts electrical power consumption during all load phases.

This allows **SECOTEC** refrigeration dryers to save almost 60% of energy costs compared to refrigeration dryers with hot gas bypass control running at an average capacity of 40%. **The TF 340 model typically saves 20,000 kWh/year based on 6,000 operating hours.** In contrast to conventional systems, the thermal mass in **SECOTEC** dryers always remains cool.

Elektrische Leistungsaufnahme bei Nennbedingungen

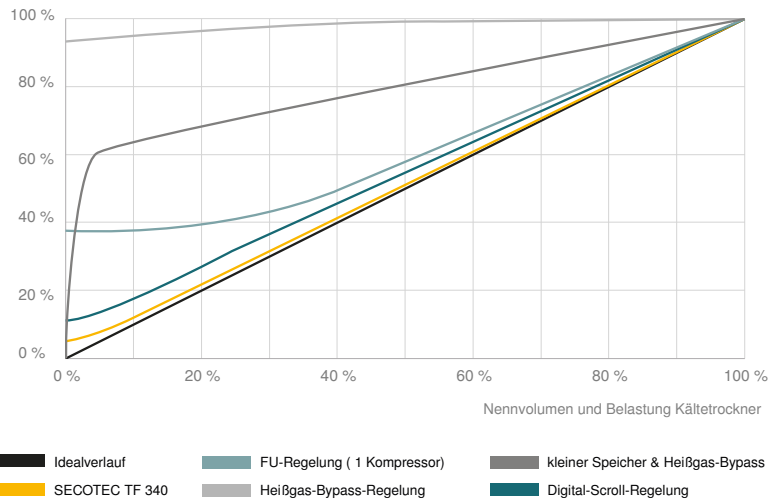

This means compressed air can be dried effectively even during start-up phases. The high-quality insulation around the thermal mass also helps keep energy use to a minimum. Compressed air drying with **SECOTEC** refrigeration dryers not only ensures exceptional energy efficiency, but also, thanks to their impressive thermal capacity, provides material-friendly operation.

Optimal drying with material-friendly operation

SECOTEC refrigeration dryers efficiently maintain pressure dew points down to +3°C during full load operation. Thanks to their narrow fluctuation range, pressure dew points are also more stable during partial load operation than is the case with conventional refrigeration dryers.

Conventional refrigeration dryers with switching operating modes, but without an additional thermal mass, use the heat exchanger material itself as a thermal mass. In these dryers it is therefore necessary to switch the refrigerant compressors and fan motors on and off much more frequently, in order to maintain the required cooling performance.

To reduce switching frequency and wear, the refrigerant circuit therefore only switches on at much higher pressure dew points. The resulting pressure dew point fluctuations negatively affect drying performance. This can be risky, since corrosion can take hold even with relative compressed air humidity of 40% – corrosion can therefore occur even without condensate formation.

Drucktaupunkt in °C

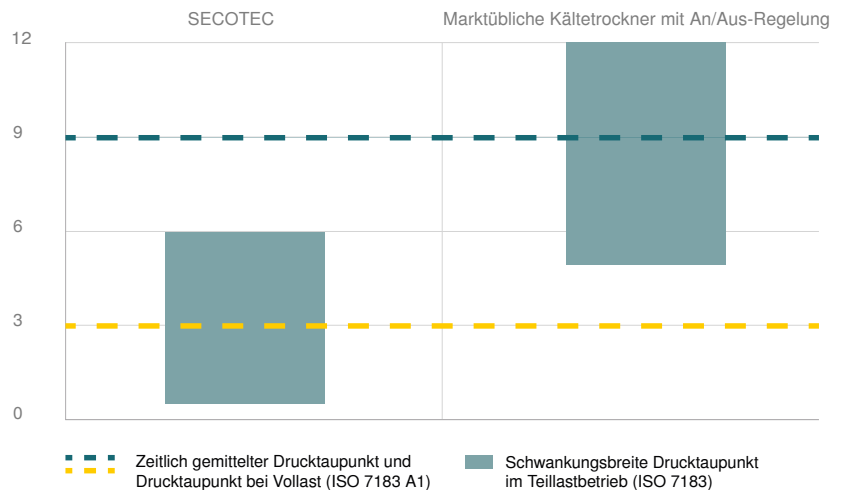

SECOTEC refrigeration dryers, on the other hand, ensure material-friendly operation thanks to their high thermal mass storage capacity. Once the thermal mass has been charged, the refrigerant compressor and fan motor can remain switched off for much longer with no impact on pressure dew point stability.

Standard equipment

Refrigeration circuit

Refrigeration circuit comprising up to three refrigerant compressors, aluminium microchannel condenser with fan, pressure monitor, filter dryer, refrigerant collector, thermostatic expansion valve, SECOPACK LS aluminium heat exchanger system and pressure transducer.

SECOPACK LS

Air/air and air/refrigerant heat exchanger with aluminium block design, integrated thermal mass section with phase change material, condensate separator, heat insulation and temperature transducer.

SIGMA CONTROL SMART

Electronic controller with colour display, language-neutral menu navigation, dew point trend indicator, P&I diagram with current operating data and messages, message memory, operating hour counter and maintenance timer.

Enclosure

Powder-coated enclosure. Removable access panel (TG series: door) for easy electrical connection and efficient cleaning of the condenser. Removable side access panel (TG series: side doors) serves as main access point to the interior. Machine feet.

Condensate drainage

ECO-DRAIN 31 Vario electronic condensate drain with ball valve on the condensate inlet line, incl. insulation of cold surfaces.

Floating contacts

Messages: "Fault", "Warning / maintenance", "Pressure dew point warning"; operating messages: "A refrigerant compressor is running" plus access for "Remote On/Off".

Connections

Compressed air pipework constructed from corrosion-resistant materials. Bulkhead for connection of the external condensate line and cable bushing for mains power connection on rear wall.

Electrical equipment

Electrical equipment and testing as per EN 60204-1 "Safety of machinery". Control cabinet IP 54 protected.

Modbus TCP communications module

With the communications module, SECOTEC refrigeration dryers can be integrated into the SIGMA NETWORK or connected to a central control system (optional with TD series).

Calculating flow rate

Correction factors for deviating operating conditions (flow rate in m³/min x k...)

Working pressure p at dryer inlet														
p bar _(g)	3	4	5	6	7	8	9	10	11	12	13	14	15	16
k _p (TG 980)	0.64 (0.50)	0.75 (0.63)	0.84 (0.75)	0.92 (0.88)	1.00	1.05	1.09	1.12	1.16	1.19	1.22	1.24	1.26	1.27

Compressed air inlet temperature T _i							
T _i (°C)	30	35	40	45	50	55	60
k _{Ti} (TG 980)	1.19 (1.0)	1.00	0.80	0.66	0.51	0.43	0.35

Ambient temperature T _a						
T _a (°C)	25	30	35	40	45	50
k _{Ta}	1.00	0.96	0.92	0.88	0.85	0.80

Example:			
Working pressure:	10 bar _(g)	(See table)	k _p = 1.12
Compressed air inlet temperature:	+40°C	(See table)	k _{Ti} = 0.80
Ambient temperature:	+30°C	(See table)	k _{Ta} = 0.96

TF 340 refrigeration dryer with flow rate 34.0 m ³ /min	
Max. possible flow rate under operating conditions	
V _{max} Operation = V _{Reference} x k _p x k _{Ti} x k _{Ta}	
V _{max} Operation = 34.0 m ³ /min x 1.12 x 0.8 x 0.96 = 29.25 m ³ /min	

Technical specifications

Model	TD series				TE series			TF series				TG series					
	TD 52	TD 67	TD 73	TD 94	TE 102	TE 122	TE 142	TF 174	TF 230	TF 280	TF 340	TG 450	TG 520	TG 650	TG 780	TG 980	
Flow rate	m ³ /min	5.1	6.7	7.3	9.4	11.5	12.5	15.5	17.0	23.0	28.0	34.0	45	52	65	78	98
Refrigeration dryer pressure loss	bar	0.12	0.11	0.13	0.11	0.11	0.13	0.14	0.13	0.15	0.19	0.17	0.14	0.19	0.12	0.17	0.25
Electrical power consumption at 50 % vol.	kW	0.31	0.37	0.49	0.5	0.50	0.52	0.77	0.79	0.97	1.11	1.29	1.55	1.85	2.02	2.48	3.61
Electrical power consumption at 100 % vol.	kW	0.61	0.78	0.95	0.92	1.08	1.12	1.51	1.61	2.20	2.45	2.87	3.28	3.89	4.83	5.88	9.82
Gauge pressure	bar	3 to 16				3 to 16			3 to 16				3 to 16		3 to 13		
Ambient temperature	°C	+3 to +50				+3 to +45			+3 to +45				+3 to +50				
Max. compressed air inlet temperature	°C	+60				+60			+60				+60				
Weight	kg	132	138	138	151	229	230	249	345	375	395	420	637	658	704	700	763
Dimensions W x D x H	mm	588 x 797 x 1515				712 x 982 x 1612			835 x 1230 x 2000				1025 x 1656 x 2127				
Comp. air connection		G 1½	G 1½	G 1½	G 2	G 2			DN 65	DN 80			DN 100		DN 150		
Condensate drain connection		G ¼				G ¼			G ¼				G ¼				
Power supply		230 V / 1 Ph / 50 Hz				400 V / 3 Ph / 50 Hz			400 V / 3 Ph / 50 Hz				400 V / 3 Ph / 50 Hz				
Refrigerant		R-513A				R-513A			R-513A				R-513A				
Global warming potential (GWP)		631				631			631				631				
Refrigerant weight	kg	0.72	0.82	0.82	0.93	1.50	1.55	1.55	2.80	2.90	3.40	4.50	4.30	4.35	6.40	6.00	7.90
Refrigerant weight as CO ₂ equivalent	t	0.45	0.52	0.52	0.59	0.95	0.98	0.98	1.77	1.83	2.15	2.84	2.71	2.74	4.04	3.79	4.98
Options																	
Water-cooled refrigeration dryer		Not available				Not available			Optional				Optional				
Bolt-down machine feet		Optional				Optional			Optional				Optional				
Integrated autotransformer to accommodate various mains voltages		Not available				Optional			Optional				Not available				
Ambient temperature up to +50 °C		Standard				Optional			Optional				Standard				
Left-side compressed air connections		Not available				Not available			Optional				Not available				
Modbus TCP communications module		Optional				Standard			Standard				Standard				

Performance data for reference conditions to ISO 7183, Option A1: Reference point: 1 bar(a), +20 °C, 0 % relative humidity; pressure dew point +3 °C, operating point: 7 bar working pressure, compressed air inlet temperature +35 °C, 100 % relative humidity, cooling air inlet temperature +25 °C. Contains fluorinated greenhouse gas.

TD series

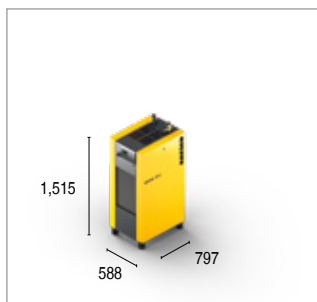

TE series

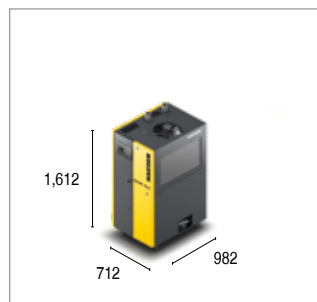

TF series

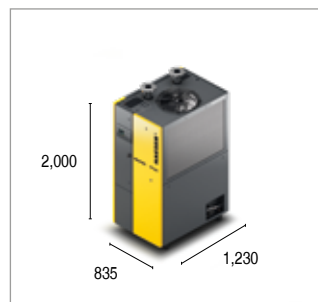

TG series

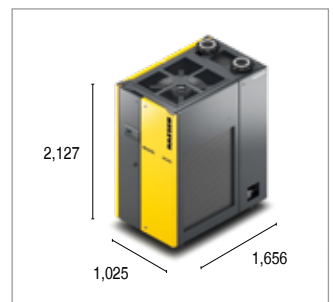

The world is our home

As one of the world's largest manufacturers of compressors, blowers and compressed air systems, KAESER KOMPRESSOREN is represented throughout the world by a comprehensive network of wholly owned subsidiaries and authorised distribution partners in over 140 countries.

By offering innovative, efficient and reliable products and services, KAESER KOMPRESSOREN's experienced consultants and engineers work in close partnership with customers to enhance their competitive edge and to develop progressive system concepts that continuously push the boundaries of performance and technology. Moreover, decades of knowledge and expertise from this industry-leading systems provider are made available to each and every customer via the KAESER group's advanced global IT network.

These advantages, coupled with KAESER's worldwide service organisation, ensure that every product operates at the peak of its performance at all times, providing optimal efficiency and maximum availability.



KAESER KOMPRESSOREN SE

P.O. Box 2143 – 96410 Coburg – GERMANY – Tel +49 9561 640-0 – Fax +49 9561 640-130
E-mail: productinfo@kaeser.com – www.kaeser.com